

FURNITURE AND AUXILIARIES

FURNITURE

Depth 48,5

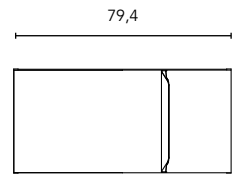

Depth 51

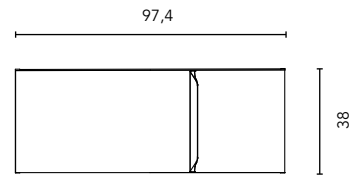

Depth 48,5

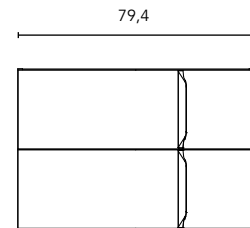

Depth 51

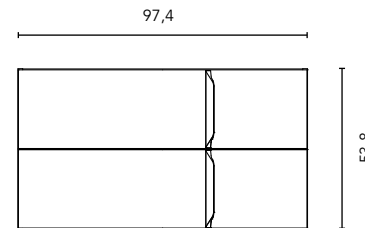

For single-drawer cabinets, 1 organiser box is included,  
for two-drawer cabinets, 2 organiser boxes are included.

BASE UNIT

Depth 43

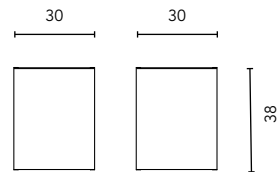

RIGHT

LEFT

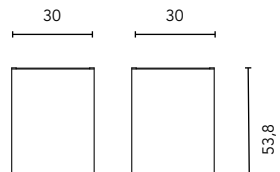

RIGHT

LEFT

COLUMN

Depth 24

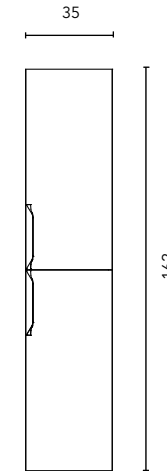

WALL UNIT

Depth 15

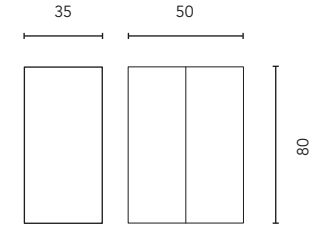

FINISHES



NATURE WHITE



NATURE BEIGE

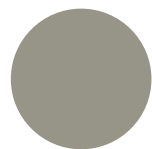

MATT SAND

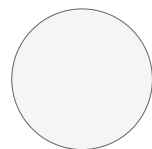

MATT WHITE

AUXILIARIES

WORKTOPS

Wrapping foil in 3D thickness 1,8 / Mineral cover - Thickness 1,2 / Marble stone - Thickness 2

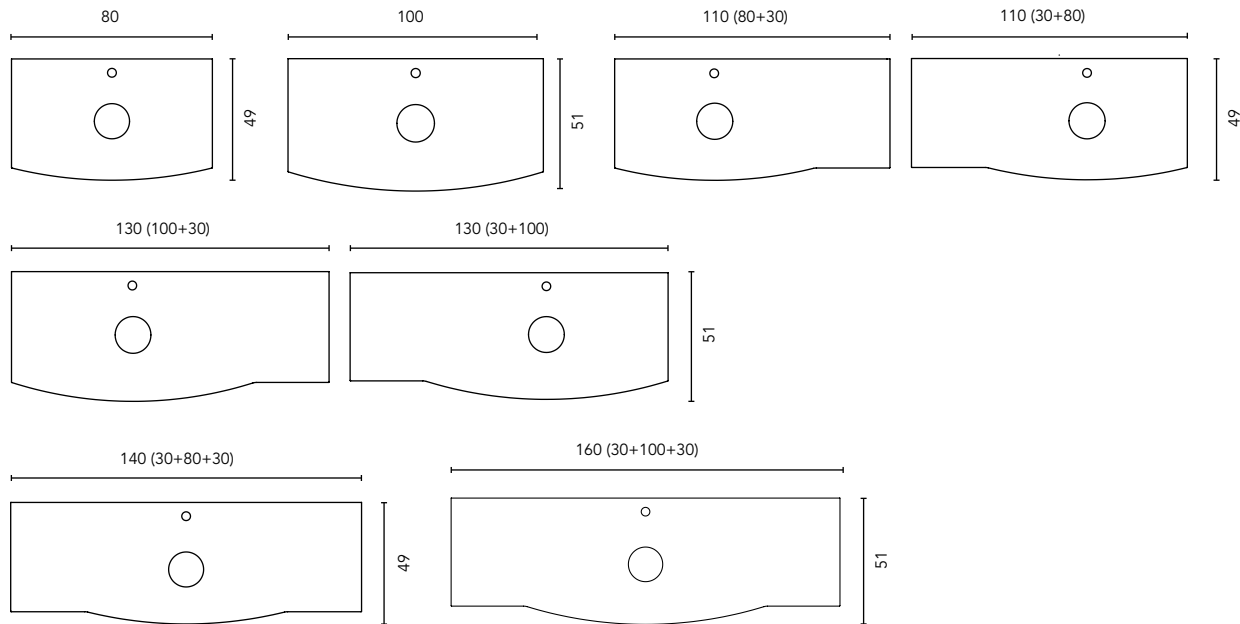

The measures given in parenthesis indicate the units necessary for this composition.

Finishes:  
Solid Surface 3D

Tube depth 7 cm.

1 Drawer

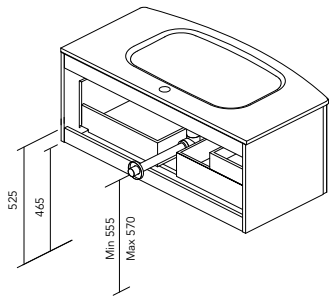

2 Drawers

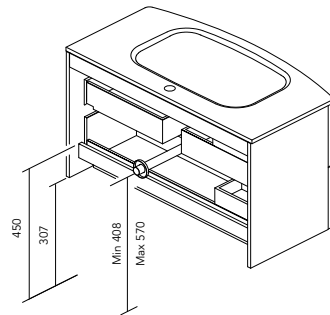

SIDE PANELS	FRONTS	DRAWERS				FINISHES	HANDLE	RANGE	
Fiberboard 16 mm	MDF. 18 mm	Partially extraction Hettich	Smoky leather interior	Drawer organiser	Soft close	Foil 3D	Patented covered handle	Curved	Suspended

\* Dimensions indicated in the drawing are based on the level of the whole leg, in case of wall hanging the furniture dimensions. The measures of these schemes are represented in mm.