

MOBILI E STRUMENTI AUSILIARI

MOBILI

Profondità 45

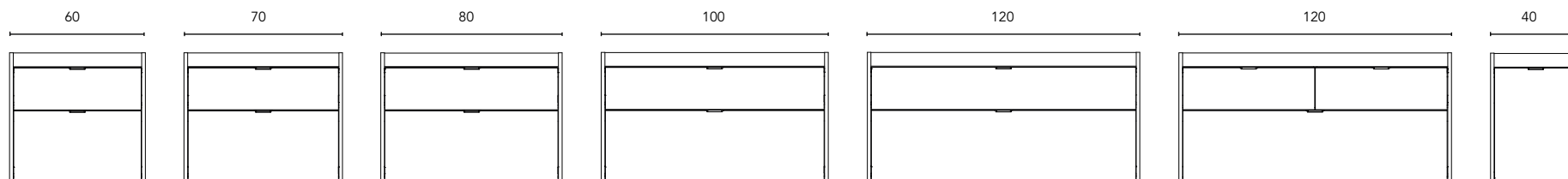

MODULO ARMADIO

Profondità 45

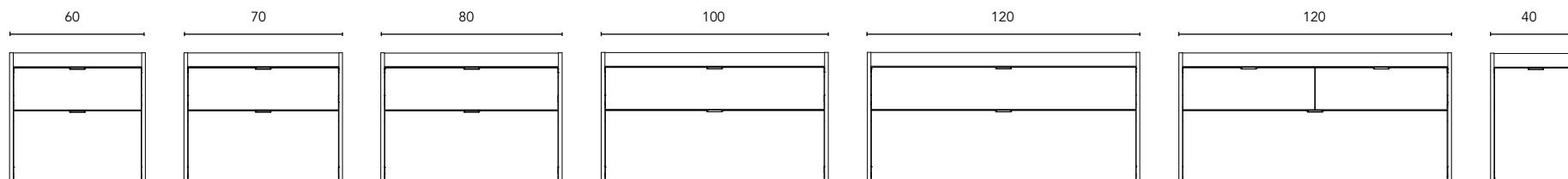

COLONNA

Profondità 24

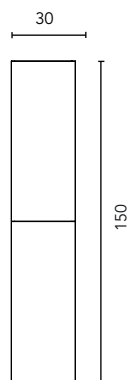

ALTO

Profondità 15

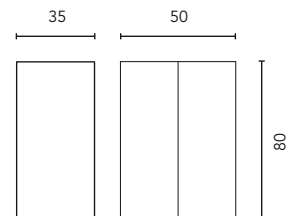

FINITURE



NOCE ARTICO

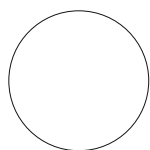

BIANCO PURE

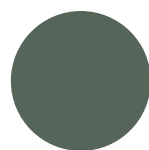

VERDE PURE

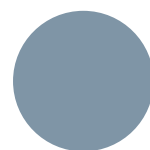

BLU TALCO PURE

Vide sanitaire 7 cm.

2 Tiroirs

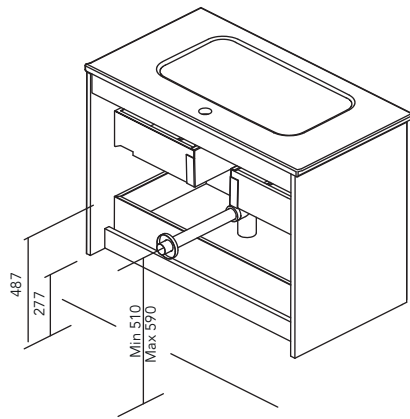

STRUTTURA	FRONTE	CASSETTI				MINIGLIA	FINITURE MOBILI	AMPIEZZA DI GAMMA	
AGL 16 mm	AGL 16 mm	Estrazione totale Hettich	Interno Anthracite	Vassoio. organiz.	Soft close	Miniglia integrato	Melamina	F-46	Sospeso

* Le dimensioni indicate nei disegni considerate in funzione dell'altezza dei piedi dei mobili, nel caso dei mobili di parete le dimensioni possono variare. Le misure presenti negli schemi sono rappresentate in mm.